

S8582-1

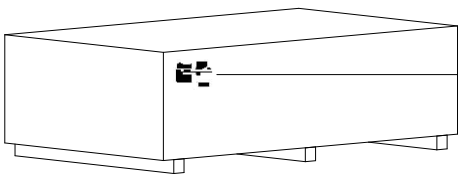

zahradní domek

návod na montáž / összeszerelési útmutató / instrukcje montażu



- (GB) Sticker
- (NL) Sticker
- (F) Autocollant
- (D) Aufkleber

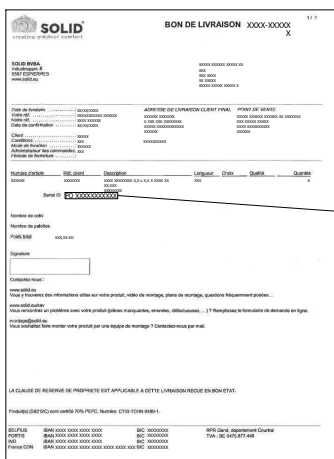

- (GB) Delivery note
- (NL) Leveringsbon
- (F) Bon de livraison
- (D) Lieferbeleg

n° PO xxxxxxxxxxxx

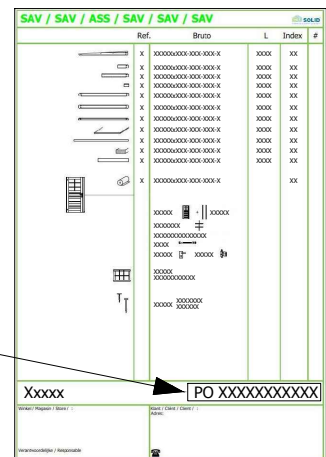

- (GB) After sales service
- (NL) Dienst na verkoop
- (F) Service après vente
- (D) Kundendienst

BERICHT IMPREGNATIE / AVERTISSEMENT IMPREGNATION

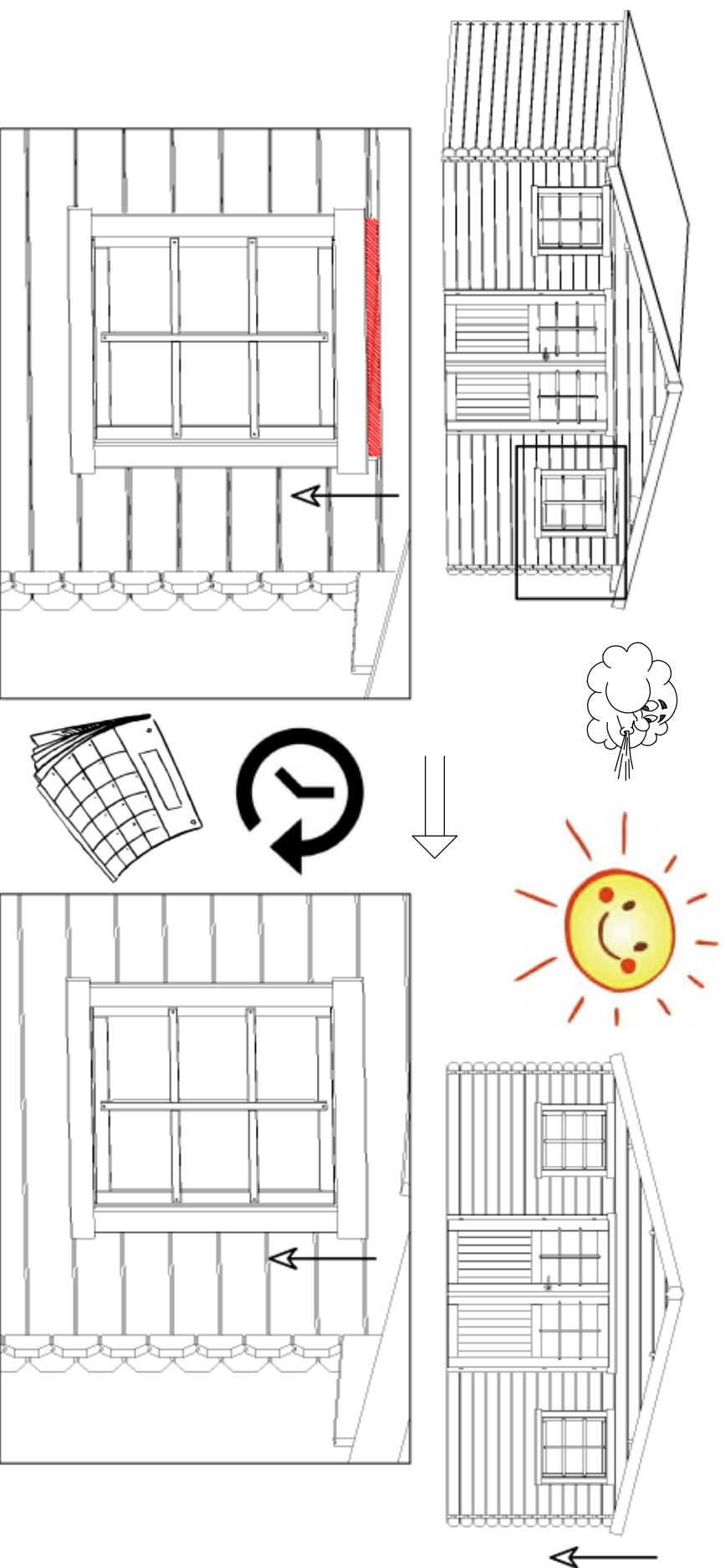

Het is niet abnormal dat openingen te zien zijn bij de montage, zowel boven de deur en de ramen als bij de dakopbouw. Deze zullen na het natuurlijk drogen van het product verdwijnen, hou er evenwel rekening mee dat dit **enkele weken** kan duren.

Il n'est pas anormal qu'il y ait des ouvertures à voir lors du montage tant au-dessus de la porte et les fenêtres qu'en montant le toit. Ceux-ci disparaîtront après le séchage naturel du produit. Tenez cependant compte que cela peut durer **quelques semaines**.

It is not unusual that small openings are visible during the assembly, both above the door and the windows as well as in the roof. These will disappear after the natural drying of the product. Keep in mind, however, that this may take **several weeks**.

Es ist nicht abnormal, dass beim Aufbau, sowohl oberhalb der Tür und den Fenstern als auch beim Dachaufbau kleine Öffnungen zu sehen sind. Nach der natürlichen Trocknung des Produktes werden diese verschwinden. Berücksichtigen Sie aber, dass dies **einige Wochen** in Anspruch nehmen kann.

S8582-1

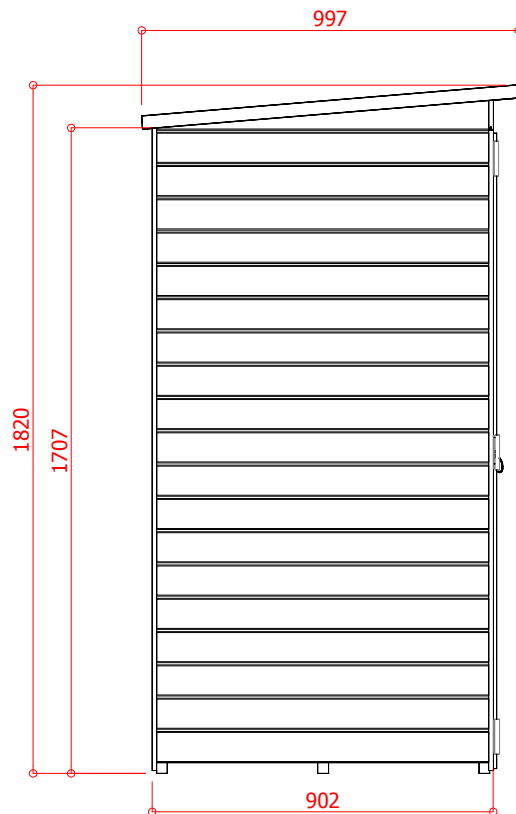
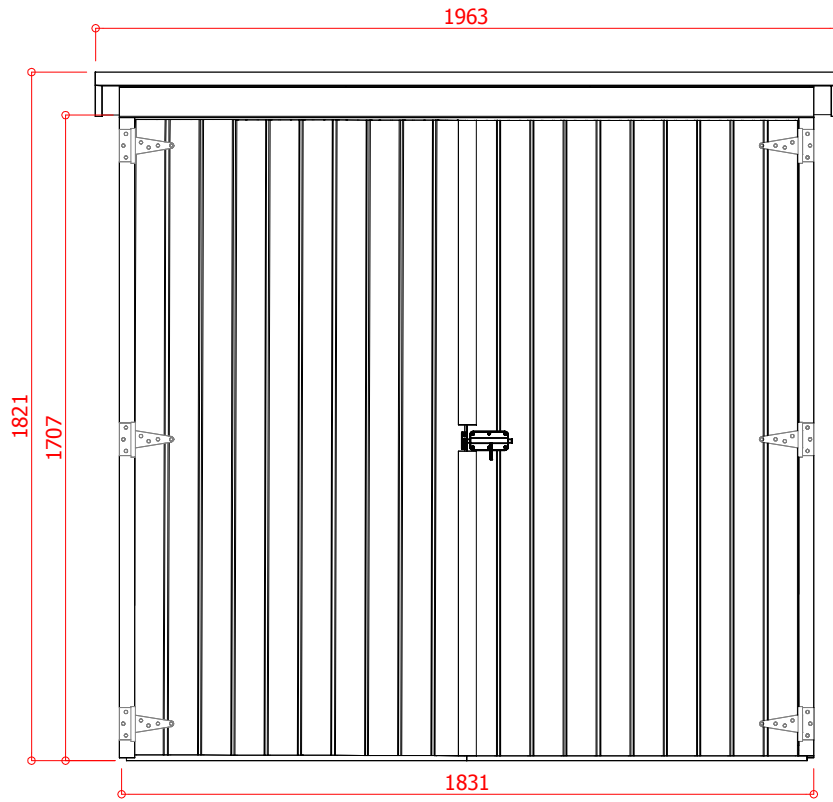

Schaal / Échelle / Scale / Escala / Escala / Scala : 1:20







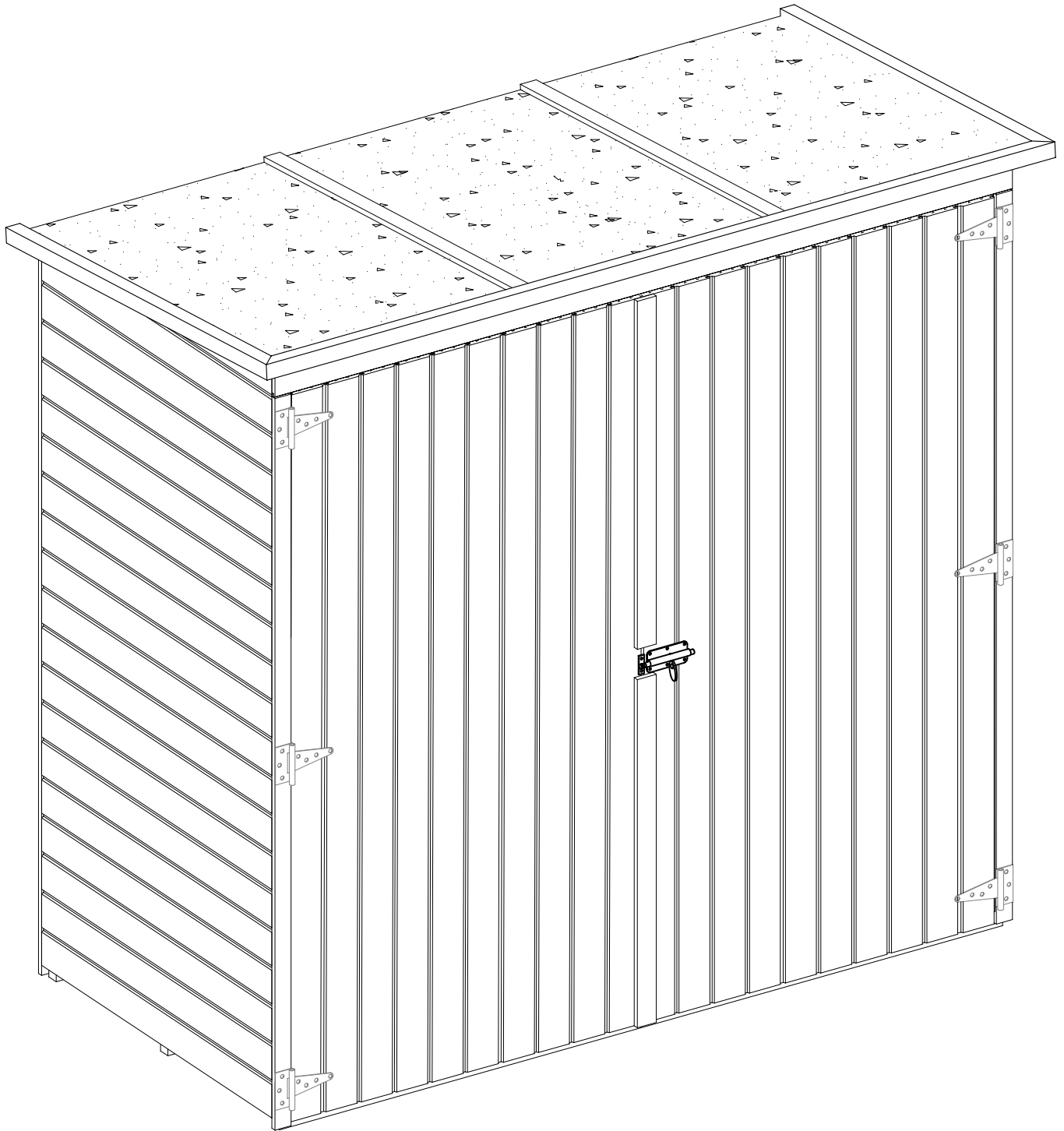







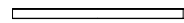
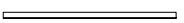
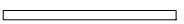
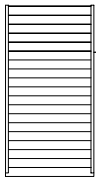





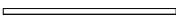

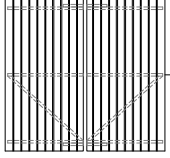

	1.65 m ²
	1.96 m ²

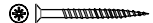
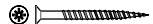
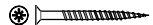
S8582-1

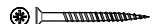

Industriepark 8
8587 Spiere-Helkijn

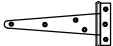
CreateDate: 28.09.2016
SaveDate: 14.02.2017
PlotDate: 14.02.2017

	Ref.	Bruto	L	Index	#
	A1	WW012x090-TPP-LIN-1	880	1	
	A2	WW012x090-TPP-REC-1	880	1	
	A3	WW047x090-4FA-000-1	1836	1	
	A4	WW012X035-4FA-000-1	1570	2	
	A5	WW035X070-4FA-000-1	1760	2	
	B1	WW012x090-VPN-000-1	880	4	
	B2	WW035x035-4FA-000-1	1760	2	
	B3	WW035x035-4FA-000-1	820	2	
	B4	WW035x035-4FA-000-1	400	2	
	J	S5921 (010 x 645)	980	3	
	L1	WW012x040-4FA-000-1	1660	2	
	L2	WW012x040-4FA-000-1	1670	2	
	L3	WW012x040-4FA-000-1	960	2	
	M	WW035x035-BAN-045-1	995	2	
	M1	WW035x035-BAN-Y45-1	1960	1	
	O	S8790	1050	2	
	P	S80812-1		1	
			4.5 x 90	8	
			4.5 x 70	4	
			4.5 x 55	24	
			4.5 x 35	32	
			4.0 x 25	48	
	R	S879-zmt	4.0 x 15	10	
			6.0 x 35	36	
			50 x 100	1	
			70 x 175	6	
	Q	S667 (#2)		1	
	S	WW012x090-BPN-000-0-	880	2	

S8582-1

PO _____

Winkel / Magasin / Store / :

Klant / Client / Client / :
Adres:

Verantwoordelijke / Responsable



S8582-1

S = 2
4.5 x 35 #8
B4 = #2

1

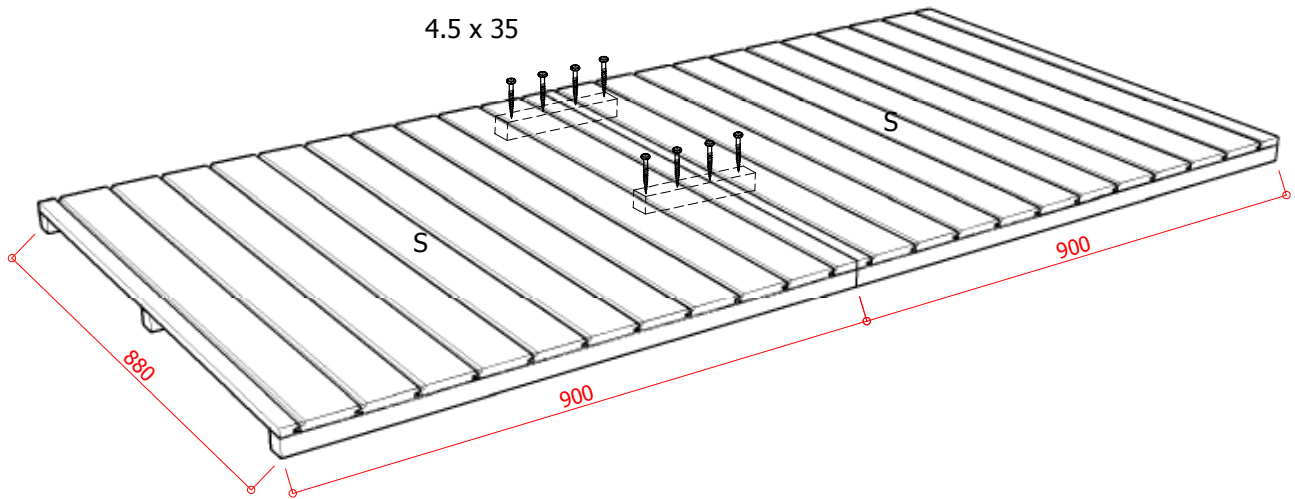

B1 = 4
B2 = 2

2

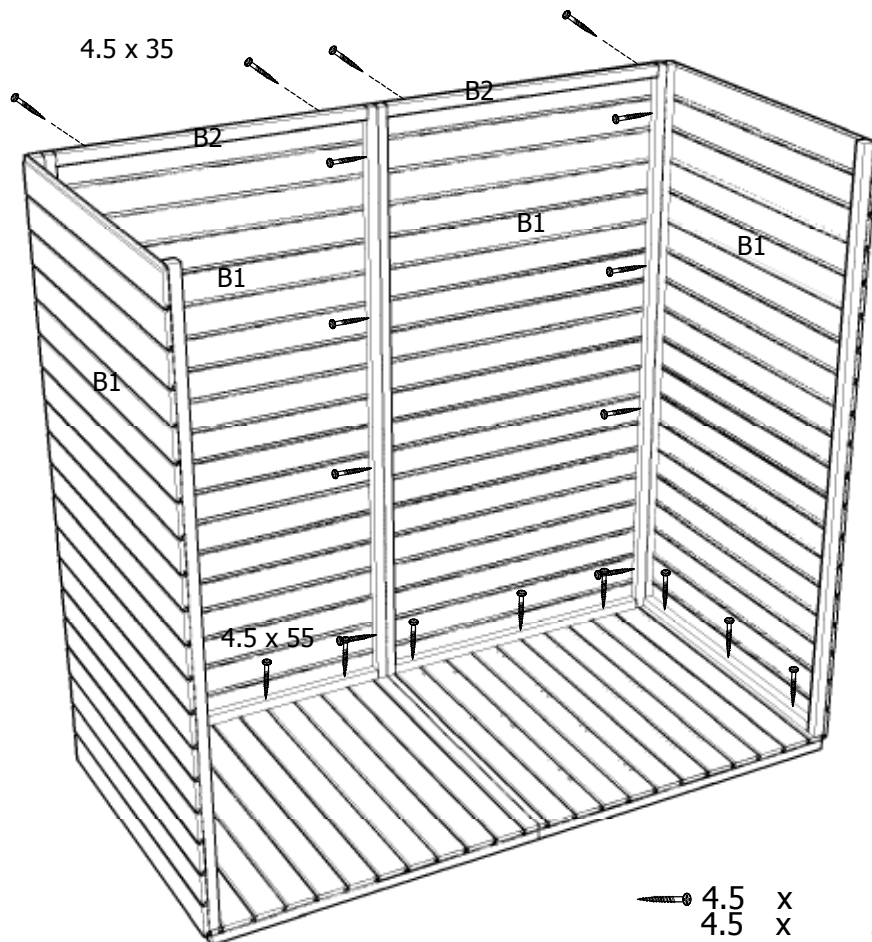

4.5 x 55 #24
4.5 x 35 #4

A5= #1
4.5 x 90 #4

4

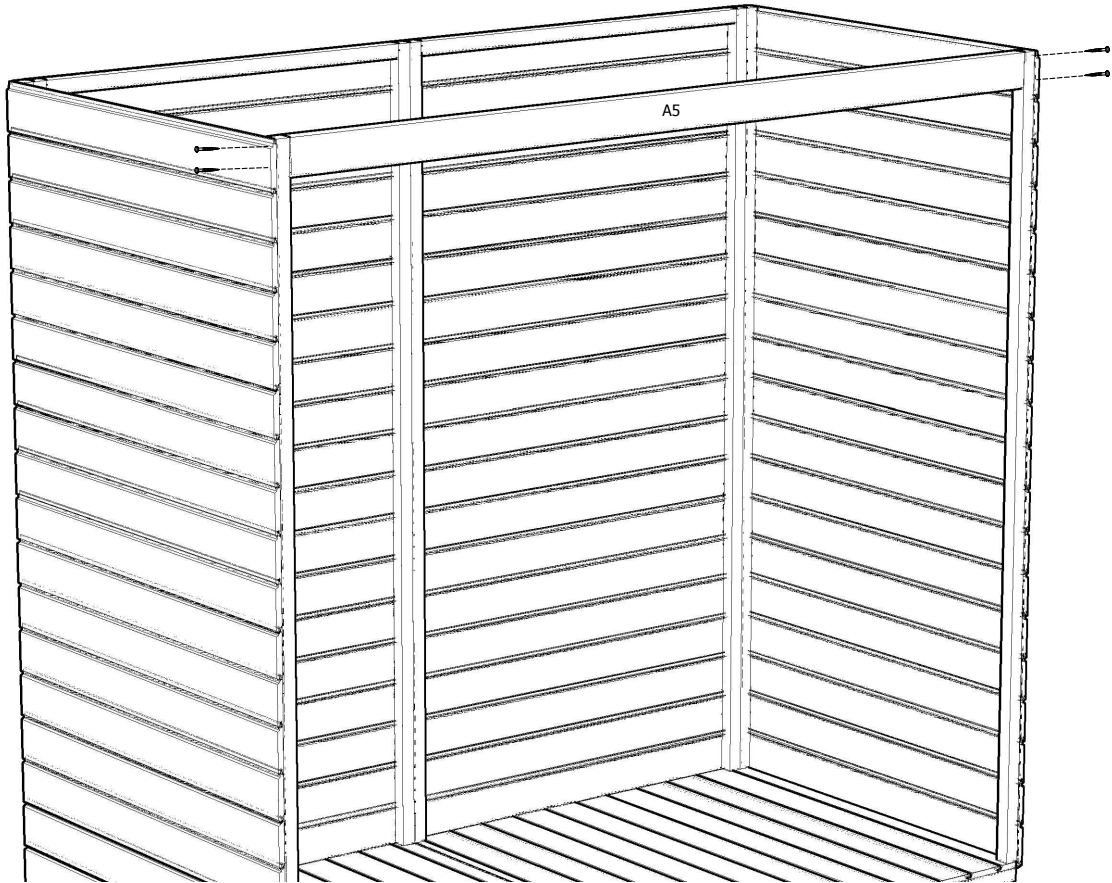

A1 = 1 | A4 = 2
A2 = 1
4.5 x 25 #8

5

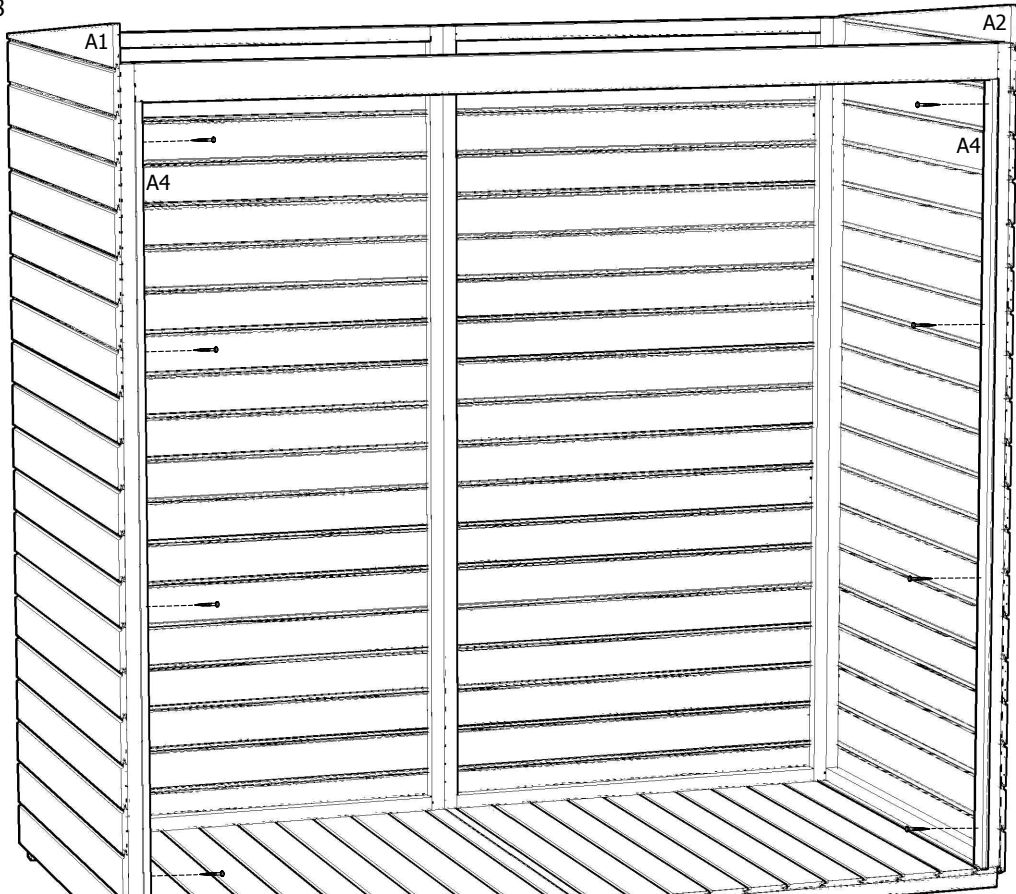

A3 = 1

4

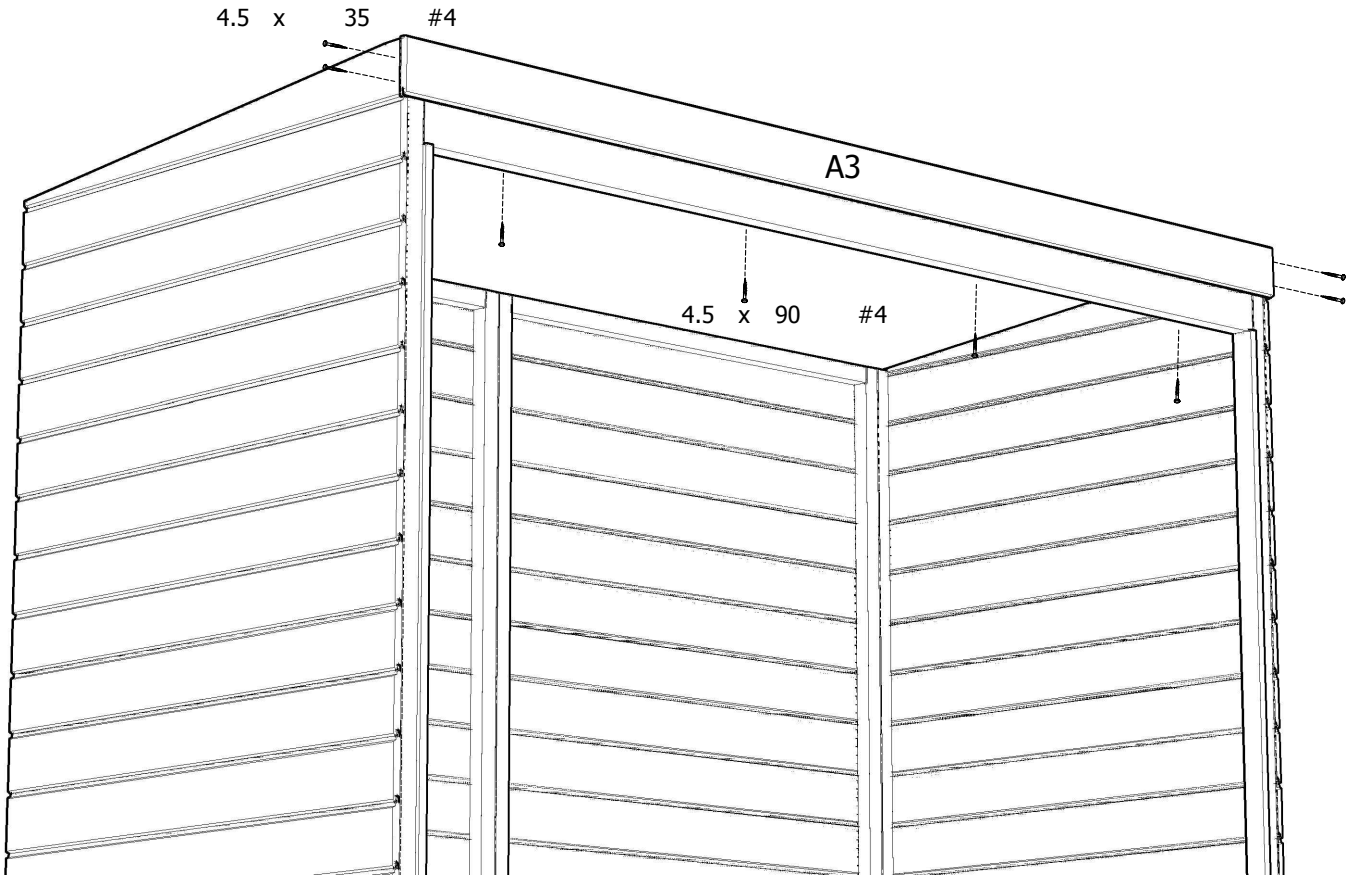

B2 = 2
4.5 x 70 #4

5

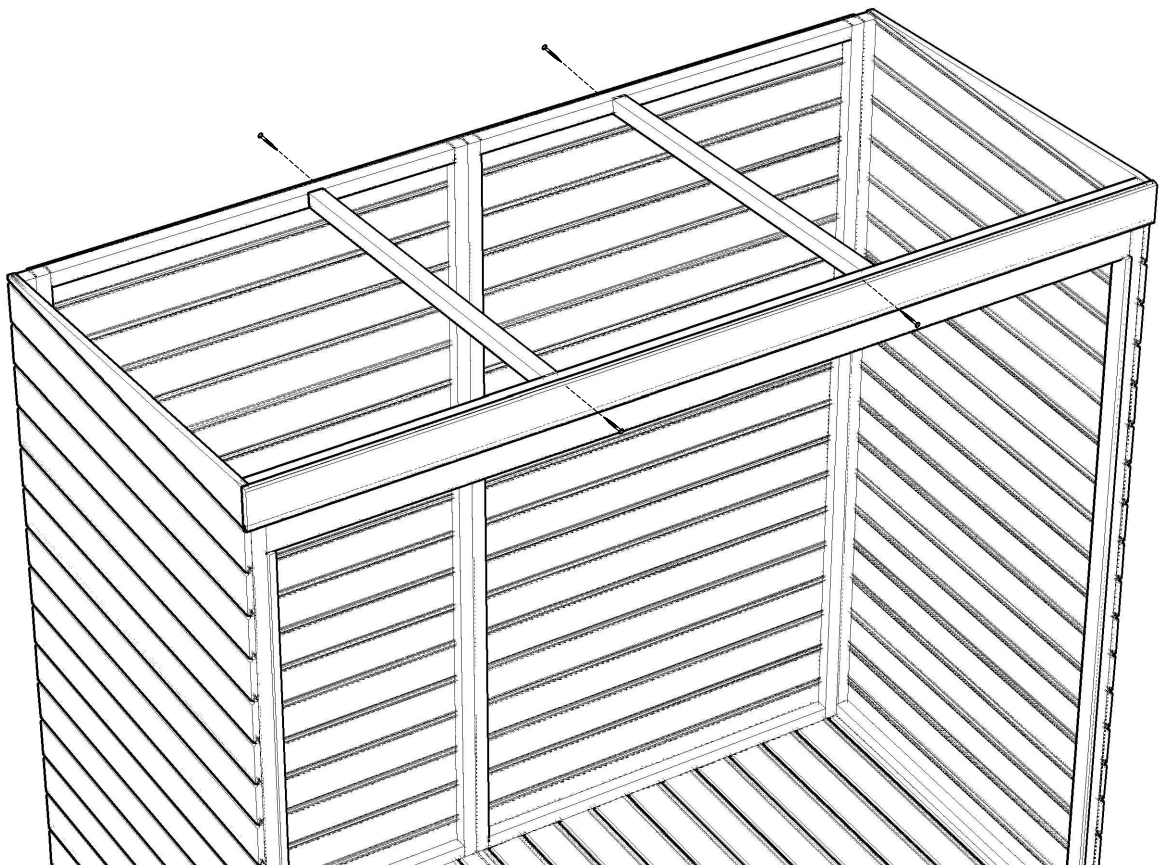

S8582-1

J = 3

 4.5 x 35 #12

6

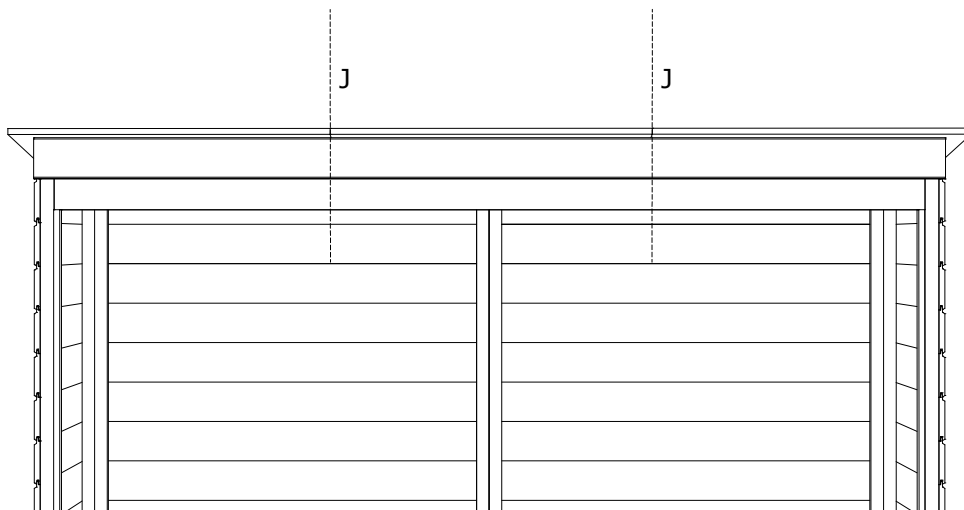
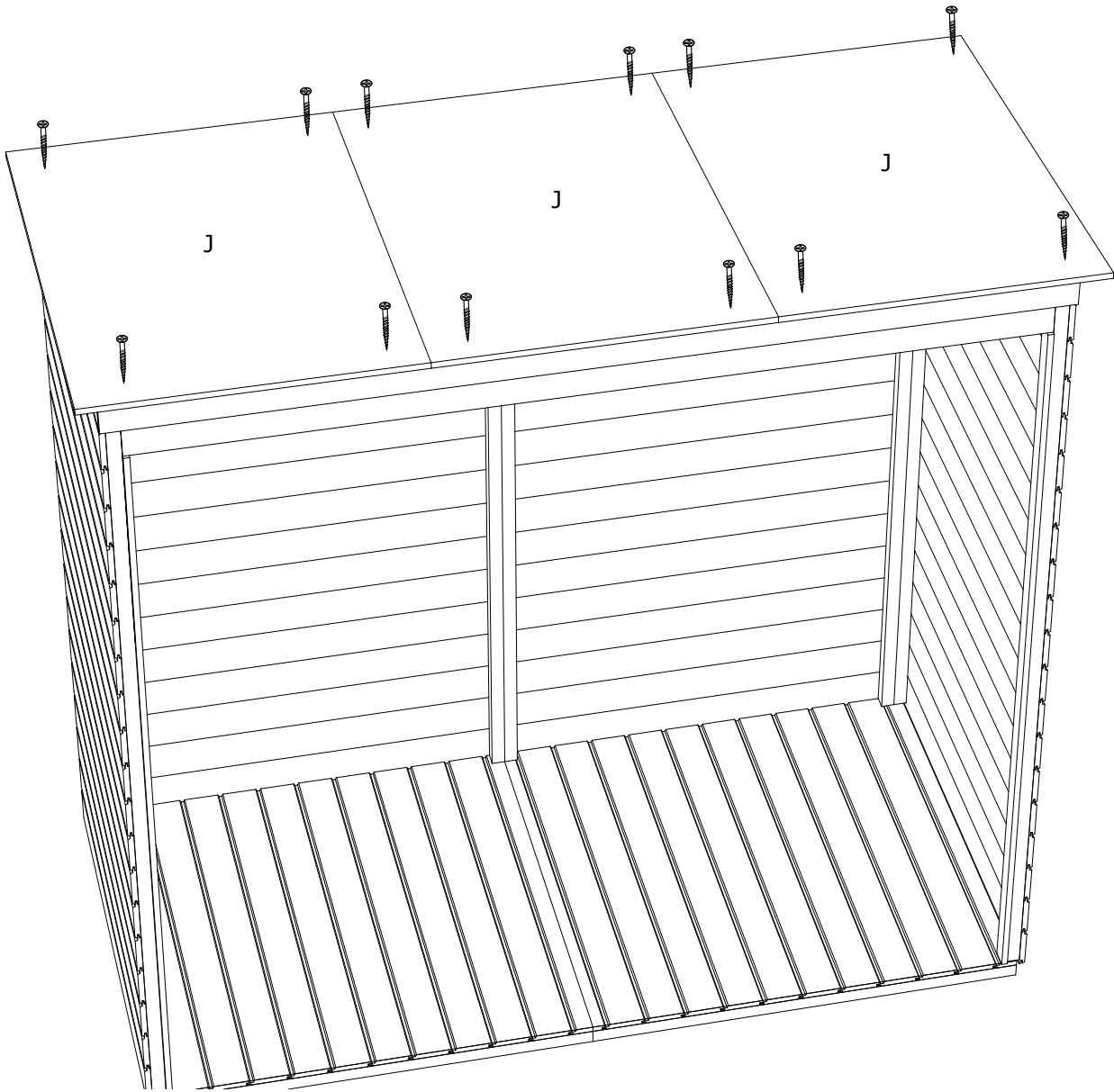

S8582-1

O = 2

8

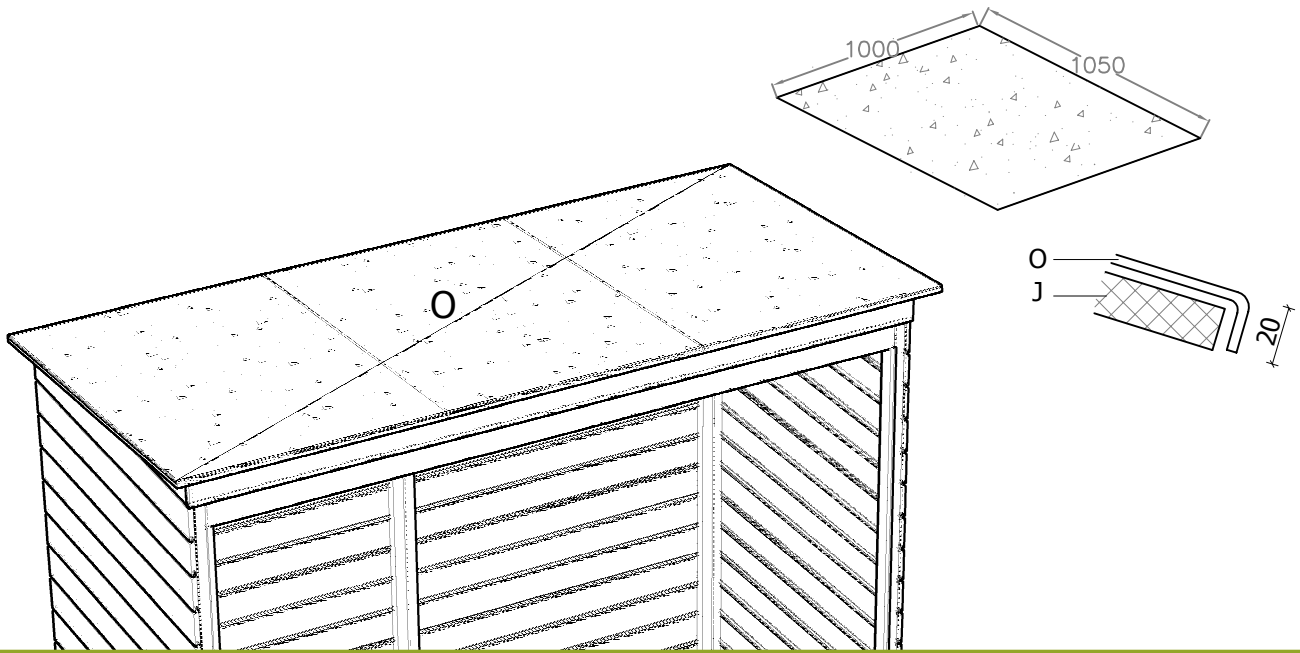

M = 2

M1 = 2

 4.0 x 25 #12

9

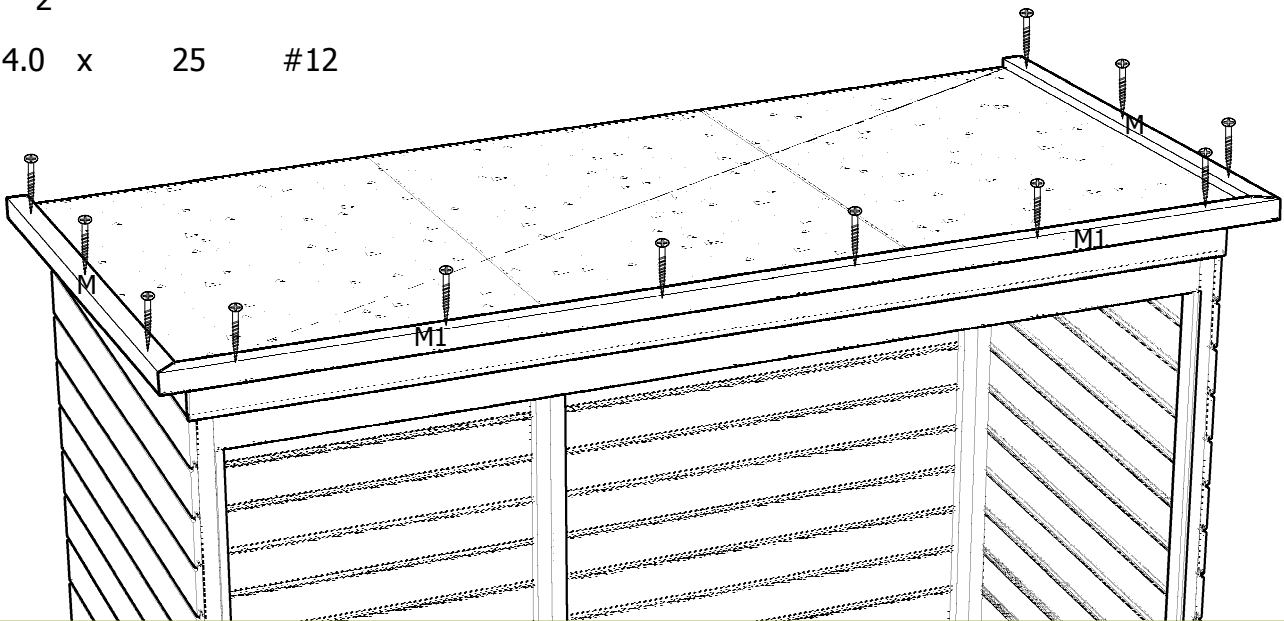

L3 = 2

 4.0 x 25 #8

9

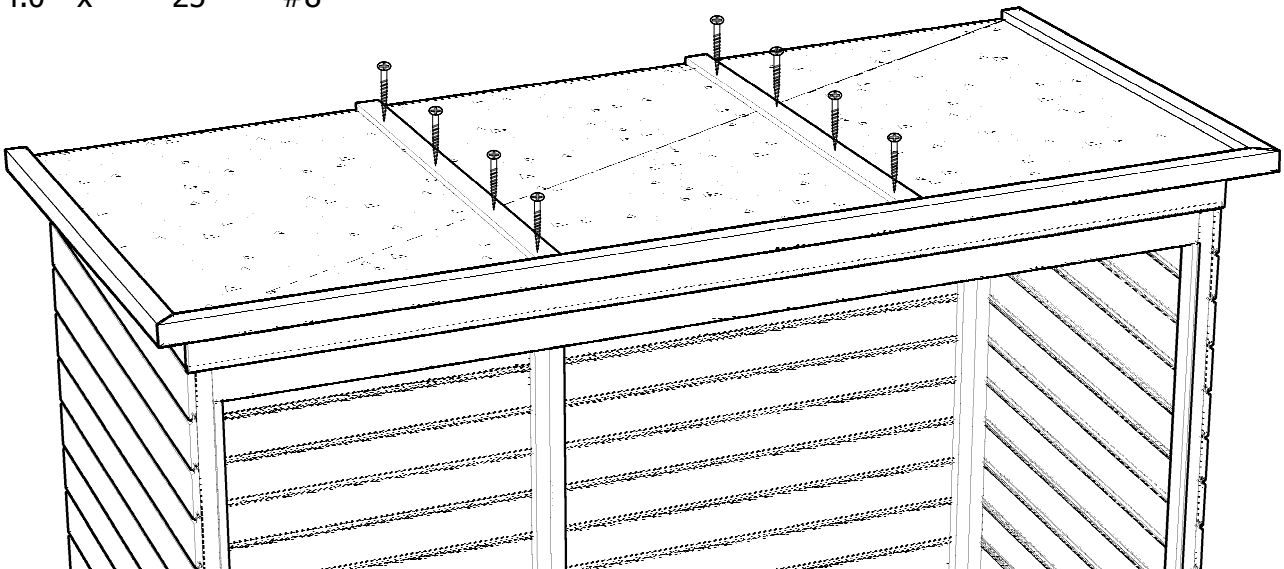

S8582-1

L1= 2

10

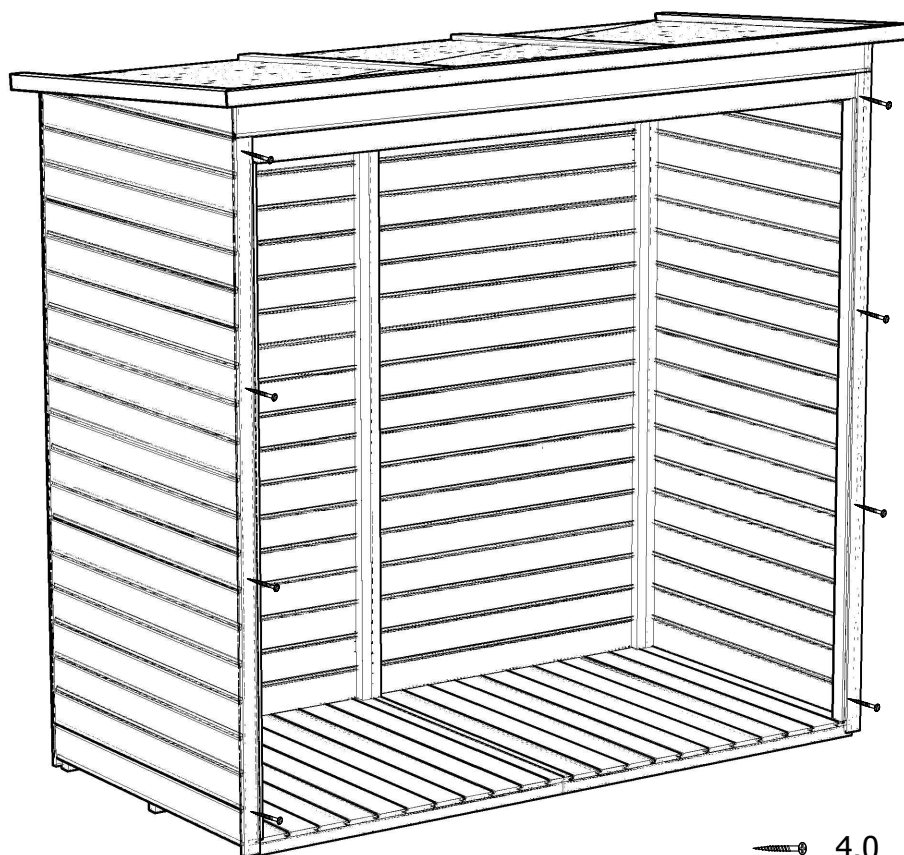



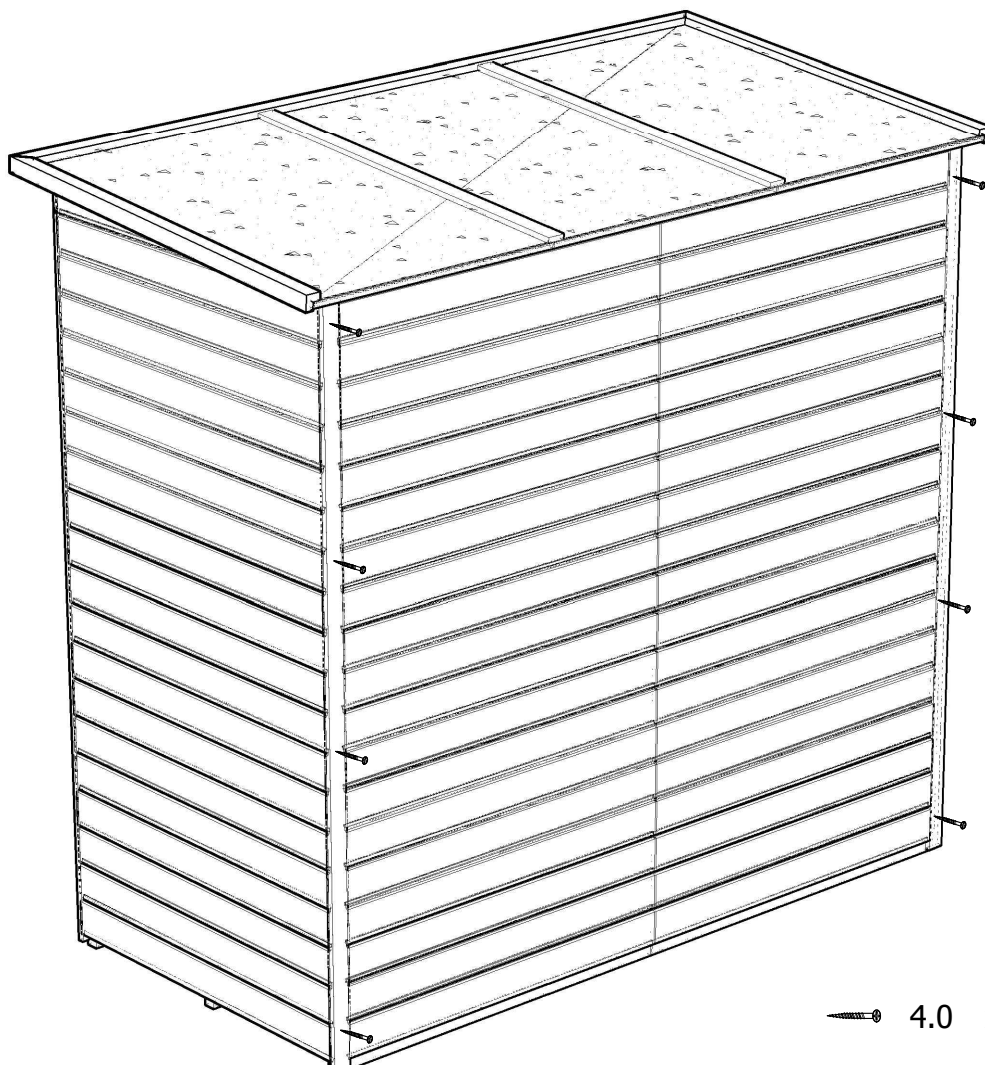

 4.0 x 25 #8

L2 = 2



 4.0 x 25 #8

S8582-1

- P = 2
- Q = 2
-  6 x 35 #36
-  4.0 x 15 #10
-  4.5 x 35 #6
-  4.0 x 25 #4

